

DROMEDAR

Sifting with Ozone

**The Guarantee of Health, Security
and
Environmental Sustainability**

A combined action of disinfection and sifting
for safe and healthy beaches



<http://www.unicorn-beachcleaners.com/>

<https://www.beach-trotters.com>

info@beach-trotters.com

Tel. +34 977 64 45 10

OZONE



Generator



Sprinklers

ADVANTAGES:

- It is a quick and efficient treatment against all types of microorganisms (virus, bacteria and fungi).
- It is environmentally friendly and it neither affects coastal fauna nor flora.
- It is an automatic treatment that does not require any workforce.
- It does not need any replenishment, since it is fuelled just by air, water and electricity.
- Maintenance and electric consumption



Electric motor of the pump



Container of ozonated water

The disinfection equipment UNICORN-O3 is composed of a generator, a container and sprinklers.

CHARACTERISTICS

Ozone (O₃) is a state of oxygen (O₂) and it is characterized by its high reactivity and oxidation potential. It removes any microorganism, renews and purifies the environment and it brings hygienic and controlled environments and liquids. After its reaction, the ozone turns back into oxygen.

Ozone oxidizes all the proteins that constitute the covering of any microorganism and modifies its tridimensional structure. As a result, the virus can not get into any cell and it dies.

We offer all the required equipment, such as basic ozone generators, ozone units fuelled by oxygen, units that are adjustable according to production or ozone units mounted on metal plate and with all the hydraulic accessories.

Respectful and ecological:

Solved into water, ozone is harmless. Because of its oxidant potential, it is used worldwide for clearance and disinfection treatments. It is also recognized as a disinfectant for water purification.

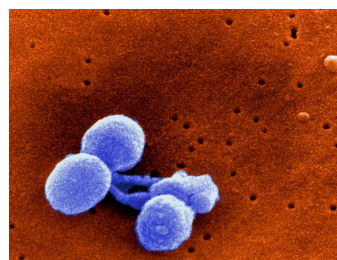

Bacteria

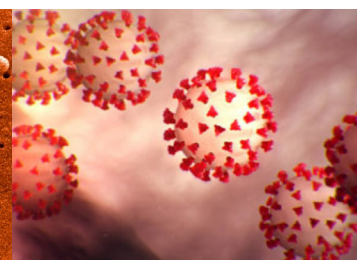

Coronavirus (Covid-19)

Disinfection action:

Ozone stands out for being a quick and efficient microbicide that destroys bacteria, virus, fungi and spores. It also offers suitable solutions for environmental problems of disinfection and smells.

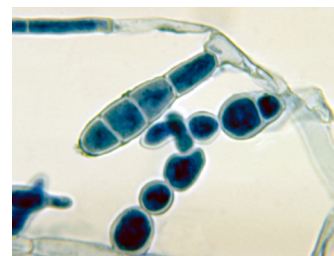

Fungi

DROMEDAR 1.9 / 2.5

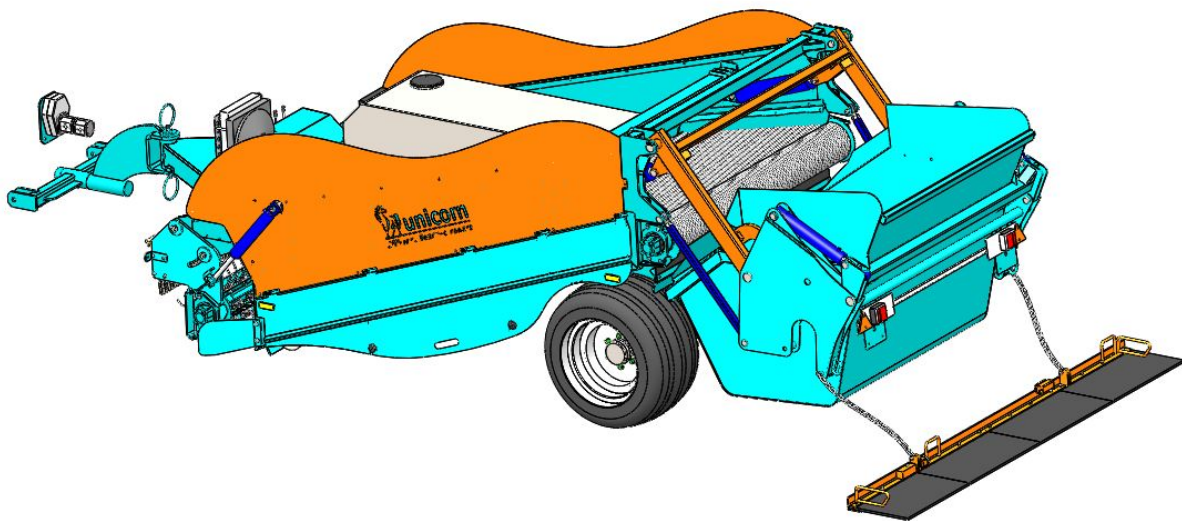

The units UNICORN Dromedar 1.9 / 2.5 are big sized machines that cover large surfaces and guarantee a perfect cleaning. According to the surface extension, we can choose between the UNICORN Dromedar 1.9 version or the Dromedar 2.5 version, thereby respectively obtaining a cleaning width of 1.9m or 2.5m.

The Dromedar allows to combine at the same time the ozone action of disinfection with the sand sifting. They can be adjusted to pick up seaweed / sargassum or to remove urban waste, such as pieces of metal, glass, plastics, etc. This combination gives the UNICORN Dromedar 1.9/2.5 an outstanding versatility, thus it can clean according to the beach conditions and user aims.

Its frontal roller can be adjusted to the cleaning aims, either to pick up seaweed / sargassum or to remove urban waste. For that purpose, its sifting system is reinforced in order to separate the sand from the seaweed.

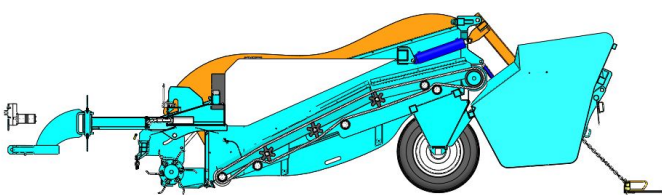

Section view

The cleaning is done by means of the sand sifting and the storage of waste in the rear hopper. The ozone treatment can be applied if necessary. The task gets finished by a final smoothing, leaving the sand even and fluffy, as well as disinfected and free from waste.

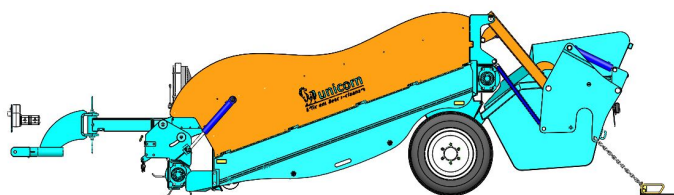

Side view

Its chassis makes the machine robust and protects it from the aggression of atmospheric agents. Optionally, all its chassis can be hot galvanized.

Thanks to its remarkable working width and depth, as well as to the shape, length and vibrating power of its mesh, the UNICORN Dromedar 1.9/2.5 can ozonize and clean a great amount of sand in a short time.

DROMEDAR 1.5

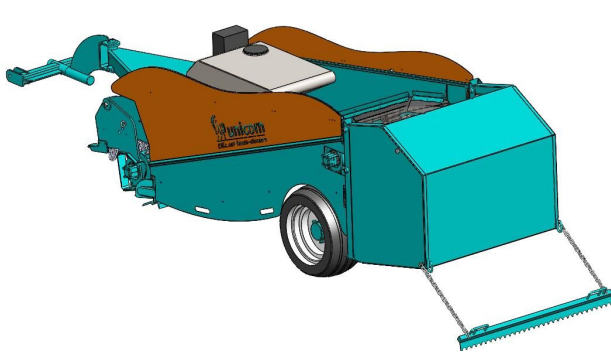

Rear perspective view

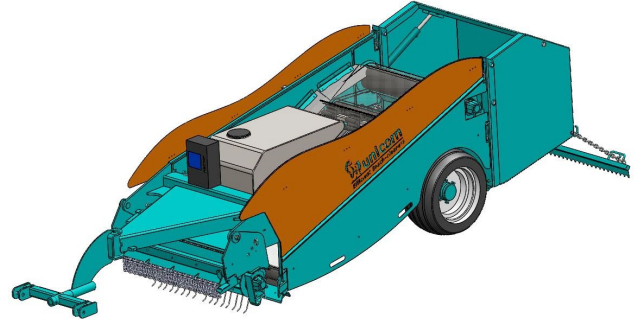

Frontal perspective view

The DROMEDAR 1.5 is a medium sized unit that is ideal for hotel professionals, campsites and beach clubs that want to clean and disinfect a beach or parts of it that are placed next to their facilities. It is a quick and maneuverable unit, which can be towed by a 60-70HP tractor.

As the rest of the UNICORN Dromedar units, it combines the sifting process with the disinfection, leaving the sand clean, fluffy and healthy, free from dangerous microorganisms that can harm the health of tourists and visitors.

It includes a smoothing bar to ensure a beautiful and attractive finishing of the beach, once the sand has been sanitized by the machine.

Its towing bar allows a high maneuverability, making the machine able to turn 180° with a radius less than four meters. Its chassis is reinforced to withstand harsh environmental conditions.

TECHNICAL CHARACTERISTICS	DROMEDAR		
	2.5	1.9	1.5
• Working width	2.500mm	1.900mm	1.500mm
• Working depth	250mm	250mm	180mm
• Loading capacity	2.5m ³	2.5m ³	1,5m ³
• Unloading height	2.5m	2.5m	1m
• External measures	6.550mm (L) 2.515mm(A) 2.020mm(H)	6.550mm (L) 2.250mm(A) 2.020mm(H)	5.909mm(L) 1.570mm(A) 1.577mm(H)
• Weight	3.270kg	2.980kg	1.750 Kg
• Rear hopper	500l	500l	250l
• Tractor type	4x4 de 90-110CV	4x4 de 90-110CV	4x4-de 60-70CV

The Ozone-Beachcleaners DROMEDAR

The OZONE-Beachcleaners of UNICORN Dromedar cover all the needs of any beach or sandy area. The user can choose any of the three models depending on the beach characteristics.

All three models have a system composed of a container, an electric pump, a regulator, a manometer and a diffusion bar with many sprinklers in order to easily cover the sifted zone and pour the ozonized water just after the sifting.

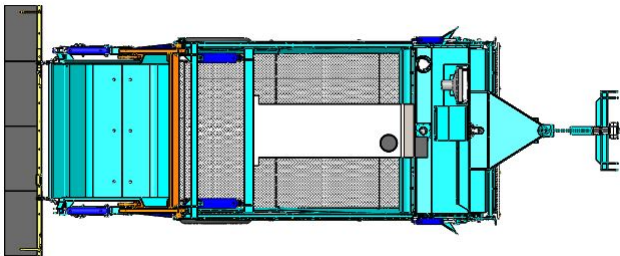

Plant view of the unit UNICORN Scarbat 2.5

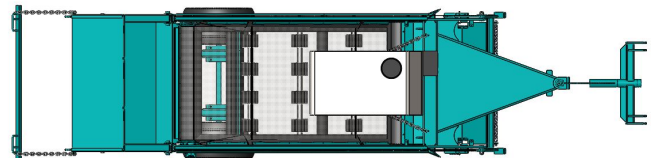

Plant view of the unit UNICORN Resort KL

Cleaning process of the beach with Ozone

For a perfect removal of virus, bacteria and fungi, the ozonized water is poured on the sand just after the sifting process. In that moment, this sand is perfectly aired, soft, clean, free from objects and fluffy. Thus, it is ready to get the gentle bathing of ozonized water that is poured on it through the sprinklers.

The amount of poured ozonized water is manual controlled by means of the flux controllers placed in the sprinklers and the power of the electric pump.



Atomizer nozzle



Electric pump

BEACH CLEANER | DROMEDAR



The frontal part of the UNICORN Dromedar is one of the more complete and improved systems available in the market. The frontal roller can be adjusted to sift both seaweed /sargassum and urban waste. In the case of sargassum, it is firstly projected to a frontal metal plate, before being sifted in the mesh.

The sprinklers with ozonated water participate in the process just afterwards, in order to ozone the sand once it has been sifted.

Other UNICORN products

www.unicorn-beachcleaners.com



TROYER



RUNNER EVOLUTION

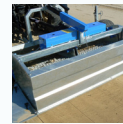

KANGUR 1.2



MUSKETEER



**MAGNUM
EVOLUTION**



KANGUR 1.35



RESORT KL 1.2



**SCARBAT
EVOLUTION 2.5**



KANGUR 1.65



RUNNER BASIC LINE



**SCARBAT
EVOLUTION 1.9**



KANGUR 2.05



MAGNUM BASIC LINE



SCARBAT BASIC LINE

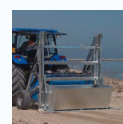

KANGUR HT

Beach cleaning machines 100% efficient